

CONTROL AND MONITORING DEVICE

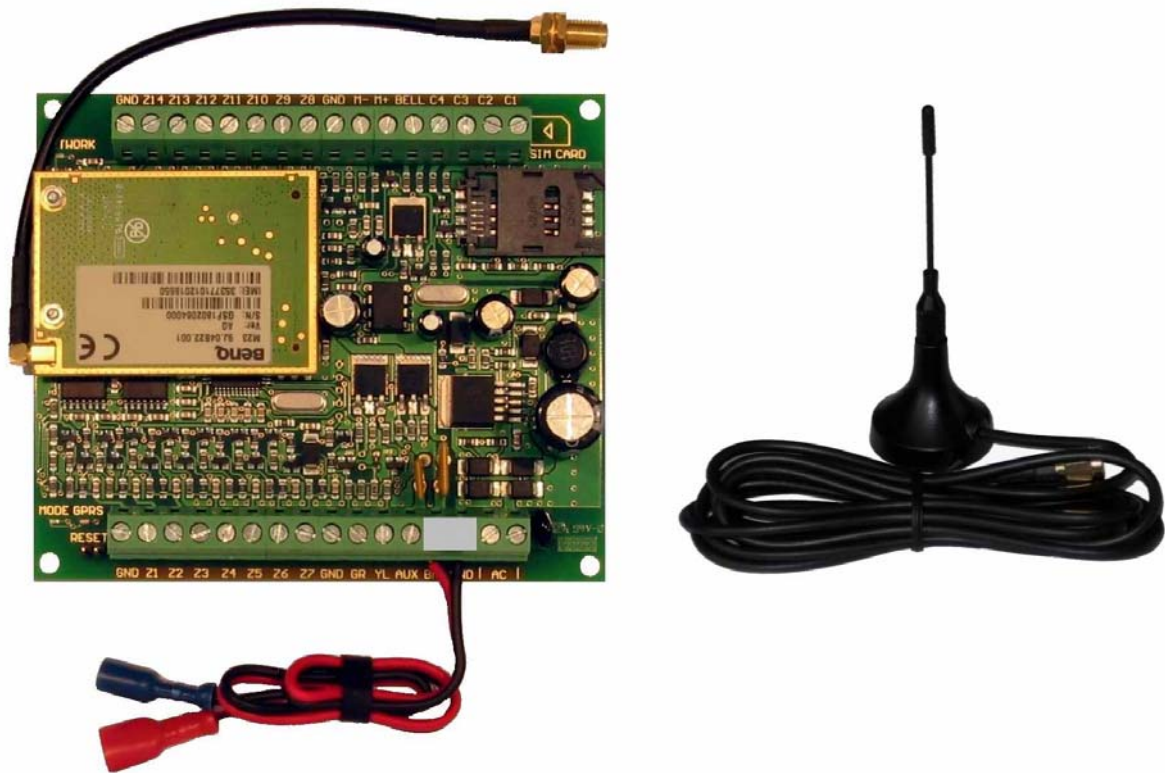

## GsmAlarm-220

Remote control and monitoring via GSM network



### FEATURES

- 14 protected zones.
- 5 programmable outputs for remote control.
- Possibility to connect two PARADOX keypads.
- 5 users are informed on the protected unit.
- Option for temperature measurement.
- 24 hour timer function.
- 250 users able to control the gate or electromagnetic lock by short free call.
- Info-carrying SMS on the state of each sensor, number of triggers, system main voltage, GSM signal strength.
- Option to connect siren.
- Option to connect external mic.
- Integrated GSM module.
- Remote programming.
- Cheap maintenance.

## Table of Contents

1. General Information.....	1
1.1. Safety Insrtuction.....	1
1.2. Package Content.....	2
1.3. General Description.....	3
2. Connectors and LEDs.....	4
2.1. Inputs Z1-Z14.....	4
2.2. Contacts GR and YL.....	4
2.3. AUX Output.....	4
2.4. Contact BAT.....	5
2.5. Contacts AC.....	5
2.6. Outputs C1, C2, C3, C4.....	5
2.7. BELL Output.....	5
2.8. Microphone Connection Contacts M- M+.....	5
2.9. RESET Contacts.....	5
3. LED Indicators.....	6
3.1. NETWORK: Indicator of Signal Strength And GSM Module Operation Mode.....	6
3.2. System Operation MODE Indicator.....	6
3.3. GPRS.....	6
4. Installation.....	7
4.1. General Installation Instructions.....	7
4.2. Connection Diagram.....	9
4.3. Connection of Temperature Sensors.....	10
5. Programming.....	11
5.1. General Programming Instructions.....	11
5.2. USSERS NUMBER Programming.....	11
5.2.1. User Number Programming with Standard Mobile Phone.....	11
5.2.2. User Number Programming with SMS.....	12
5.3. System Parameter Programming with SMS.....	14
5.3.1. Protected Zones Z1-Z16 Parameter Programming.....	14
5.3.1.1. Parameter <i>M</i> .....	15
5.3.1.2. Parameter <i>A</i> .....	15
5.3.2. Programming Of Output C1-C4, BELL and Common System Parameters <i>E, F, T</i> .....	16
5.3.2.1. Output C1-C4, BELL Operation Mode.....	17
5.3.2.2. Parameter <i>E</i> : Informing User about Arming/Disarming Mode.....	18
5.3.2.3. Parameter <i>F</i> : System Response to Incoming Calls and Number of Calls in Alarm Mode.....	18
5.3.3. System Clock Setting.....	19
5.3.4. 24 Hour Timer Setting.....	19
5.3.4.1. Timer Instructions.....	20
5.4. SMS Password Change.....	20
5.5. Programming Using <i>PARADOX ESPRIT</i> Keypad.....	21
5.5.1. User Code Programming.....	21
5.5.2. Delay Time After Arming/Disarming.....	22
5.5.3. Parameter T: Delay Time of Zones Z1-Z16 or Triggering Temperature.....	22
5.5.4. Parameter A: Operation Modes of Zones Z1-Z16.....	22
5.5.5. Parameter M: Operation Modes of Zones Z1-Z16.....	22







5.5.6. Operation Time of Outputs C1-C4 And BELL .....	23
5.5.7. Operation Mode of Outputs C1-C4 And BELL .....	23
5.5.8. Common System Parameters, Parameter „E“ .....	23
5.5.9. Common System Parameters, Parameter „F“ .....	23
5.5.10. Partial Protection Modes „STAY“ And „AWAY“ .....	24
5.5.11. Audible Indication for Delay Time .....	24
5.5.12. User Code Length (4 or 6 Digits) .....	24
5.5.13. System Clock Setting.....	24
5.5.13. System Timer Programming.....	25
<b>6. Resetting system parameters to factory defaults .....</b>	<b>26</b>
<b>6.1. Manufacturer Programmed Parameters .....</b>	<b>26</b>
<b>7. System Control Using PARADOX ESPRIT Keypad .....</b>	<b>27</b>
<b>7.1. Keypad Keys Function.....</b>	<b>27</b>
7.1.1. 2ND Key .....	27
7.1.2. TBL Key .....	27
7.1.3. MEM Key.....	27
7.1.4. BYP Key.....	28
7.1.5. CLEAR Key.....	28
7.1.6. ENTER Key.....	28
7.2. Full Protection Mode Activation .....	28
7.3. Partial Protection Mode Activation .....	28
7.4. Armed mode deactivation .....	28
7.5. Remote Arming / Disarming .....	29
<b>8. System Control, When Keypad Is Not Used.....</b>	<b>29</b>
<b>8.1. Control Using ON/OFF Switch .....</b>	<b>29</b>
<b>8.2. Remote Control.....</b>	<b>29</b>
<b>9. System Operation in Alarm Mode.....</b>	<b>29</b>
<b>10. Informing the User About Power Supply Loss .....</b>	<b>30</b>
<b>11. Control Using DTMF and SMS Instructions.....</b>	<b>21</b>
<b>12. Warranty .....</b>	<b>33</b>
<b>13. Technical Characteristics .....</b>	<b>34</b>

## GENERAL INFORMATION

### 1.1. SAFETY INSTRUCTION

**Important!** Read and strictly follow all safety and operational instructions written in this user manual, before using GsmAlarm-220 in order to guarantee safety and prevent possible injuries from possible thermal and electric device failures for you and surrounding people.

Retain all safety and operational instructions for future reference during the whole operation lifetime of device.

	Device has two power supplies: <b>main and reserve</b> . <b>Main:</b> power transformer: I: 230V 50/60 Hz; II: (16–24)V ~ 1,2 A 50/60Hz; <b>Reserve:</b> 12 V 1,2 Ah battery.
	Device GsmAlarm 220 certifies required safety level of LST EN 60950-1:2003 standard. <b><u>All power supplies described above and connected to device must satisfy the safety requirements of LST EN 60950 –1 standard!</u></b>
	<b>Additional circuit breaker</b> should be installed in AC electric power circuit to protect from over-current and short circuits.
	Only a qualified specialist possessing strong knowledge about general safety requirements and technology of device can perform system installation works and technical support. In case of any device performance disorder only qualified specialist can repair it. <b>There are no parts you can change at place in the device.</b>
	<b>ATTENTION!</b> <b>EXPLOSION POSSIBLE USING WRONG KIND BATTERIES - NOT RECOMMENDED BY MANUFACTURER.</b> <b>DO NOT SWITCH POLES OF BATTERY BY ACCIDENT.</b> <b>DO NOT SHORT CIRCUIT BATTERY POLES.</b>
	<b>MAINTENANCE PERSONNEL WARNING!</b> <b>TWO POLES OF AC ELECTRIC POWER SUPPLY.</b> <b>POWER TRANSFORMER CUT-OUT IN NEUTRAL CABLE!</b>
	<b>Disconnect device from AC power and reserve battery before performing any installation or maintenance work.</b> <b>It is forbidden to perform any device installation or maintenance work during lightning!</b>

Remote control and monitoring device GsmAlarm-220 has built-in radio transmitter operating on GSM900 and GSM1800 networks.

Do not use the device where it can cause interferences and danger.

Do not arrange the device close to medical equipment and appliances.

Do not use the device in explosive environment.

Device is not resistant to moisture, chemical materials or mechanical damage.



This symbol on the product or on its packaging means that your electrical and electronic equipment should be disposed at the end of life separately from your household wastes. There are separate collection systems for recycling in EU. For more information, please contact the local authority or the dealer where you purchased the product.

## 1.2. PACKAGE CONTENT

Device GsmAlarm-220.....	1	pcs.
GSM antenna with magnetic fix and 2 m lead cable.....	1	pcs.
Microphone with 1,5 m lead cable.....	1	pcs.
Load resistors 2,2k $\pm$ 5%.....	15	pcs.
Clamping cable for accumulator connection.....	1	pcs.
PCB fastening clips.....	4	pcs.
User's manual.....	1	pcs.

### 1.3. GENERAL DESCRIPTION

Fourteen zone control and monitoring device GsmAlarm-220 can be used for protection of houses, apartments, garages, and cottages. In the case of trespass of the protected zone GsmAlarm-220, depending on the programmed system operation algorithm, switches the siren on, calls and sends SMS messages to five users. User answers the call using his phone keypad (DTMF tones), can listen, what is going on in the unit, SMS may be received, informing about the controlled zone state, number of each zone activation.

GsmAlarm-220 has 4 (5, if siren is not used) programmable outputs, intended for remote control of different devices. User can turn on/off heating, ventilation or lighting systems etc, by using his mobile phone just by typing a relevant code or sending SMS to the control device.

Device works perfect for remote control of automated gates, fences and electromagnetic door locks. In order to open the gate, user calls GsmAlarm-220 number. Then GsmAlarm-220 checks the caller's number in the list of programmed user numbers and in the case of positive find, switches on the gate control device and cancels the call automatically. 250 users are able to control the gate.

*PARADOX ESPRIT 636, 646 or 642BL* keypads can be connected to GsmAlarm-220. We increase the number of protected zones till 16 by using two keypads. By using the keypad users can activate/deactivate full or partial protection mode, turn off armed mode, and configure system parameters. Following keypad LED indicators you can determine protected unit state, system mode etc.

System is turned on or off simply by turning the switch ON/OFF or by short free call if the keypad is not used.

The system answers only to the numbers programmed. If the system receives a call, coming not from the user's phone, the call is immediately interrupted and the user is sent SMS, specifying the caller's phone number. SMS messages are also sent to users in case of power loss and restoration.

System has temperature measurement possibility. Up to 14 temperature indicators *KTY81-110 (PHILIPS)* can be connected to GsmAlarm-220 device. If temperature exceeds or subsides programmed range, system sends SMS to user(s), relevant programmable output can be activated/deactivated.

24 hour timer function enables activation/deactivation of programmable output and armed mode, receiving SMS messages with guarded object state information on a desired time.

You can check alarm operation by short call to GsmAlarm-220 number. If GsmAlarm-220 is operative, the calling user gets a short confirmation call.

All GsmAlarm-220 parameters are programmed remotely, by sending SMS with relevant contents with password.

## 2. CONNECTORS AND LEDS

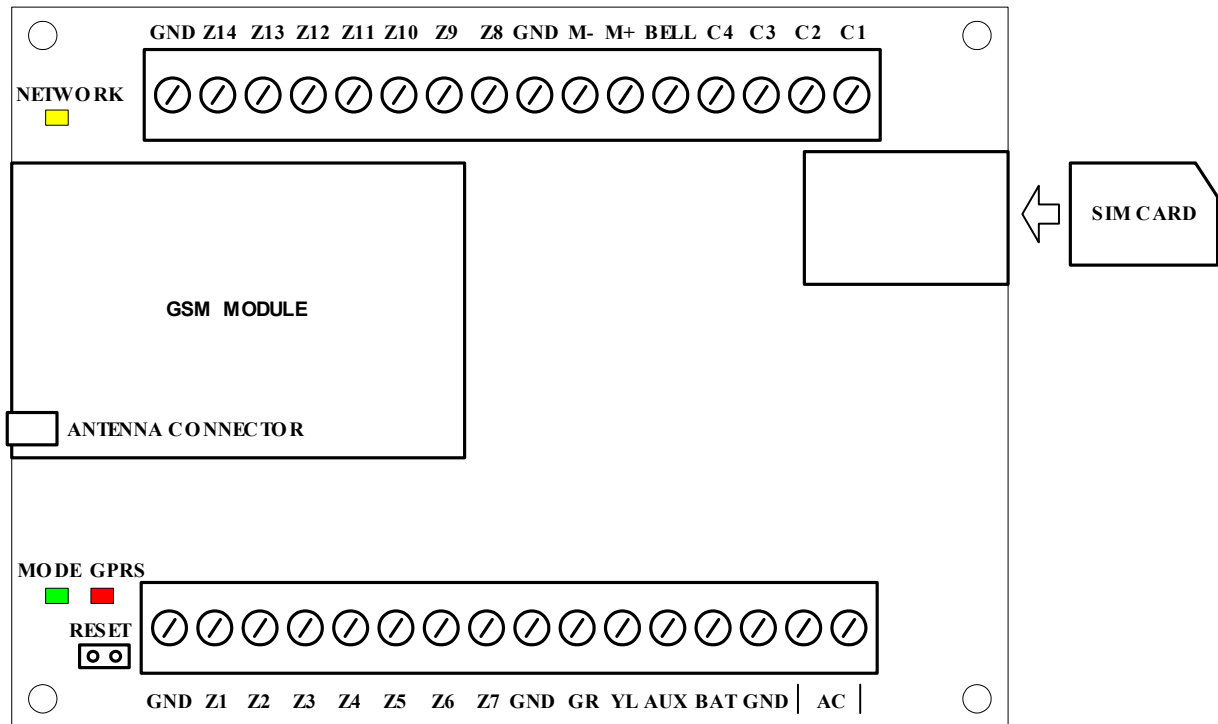

*GsmAlarm-220 connection contacts and LED indicators*

### 2.1. INPUTS Z1-Z14

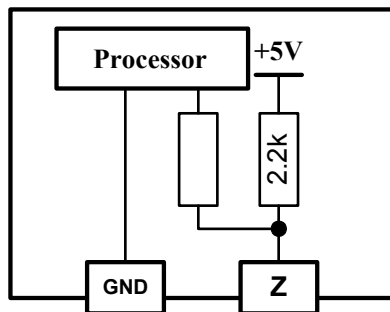

Inputs Z1-Z14 are used to connect sensors of protected zones or temperature sensors KTY81-110 (PHILIPS).

The inputs can operate in a “loaded input” mode or in a “zero-one” mode (see ch. 5.3.1.2). The “loaded input” mode is recommended to be used for protection of premises. In this case all the inputs have to be loaded with 2.2k resistors. The system becomes triggered both when the monitored input circuit is broken as well as when it is short-circuited.

In the second case the system is triggered after breaking or short-circuiting of the monitored input circuit (depending on the programmed "active" level).

*Equivalent diagram of input*

### 2.2. CONTACTS GR AND YL

Use GR and YL contacts to connect PARADOX ESPRIT 636, 646 or 642BL keypad.

### 2.3. AUX OUTPUT

AUX output is used to supply power external devices (fire, motion sensors) and is short-circuit-protected. Max load current is 1 A.

## 2.4. CONTACT BAT

“+” terminal of reserve battery is connected to contact BAT. Max capacity of the battery is 1,2 Ah. 12 V.

## 2.5. CONTACTS AC

The AC contact is used to connect secondary winding of power supply transformer (16-24V AC).

## 2.6. OUTPUTS C1, C2, C3, C4

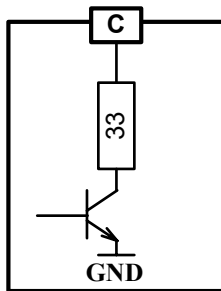

Programmable outputs C1, C2, C3 and C4 are used to connect remotely controlled devices.

Relays with 12V operation voltage and current not exceeding 150 mA max, are recommended for device control.

Output operation modes are described in ch. 5.3.2.1

*C1-C4 equivalent diagram*

## BELL OUTPUT

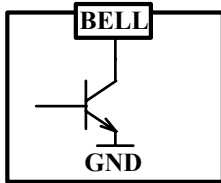

The BELL output is used to connect audio siren or extra-commutated device.

Commutated current may reach 0.6 A max.

*Equivalent diagram of BELL OUTPUT*

## 2.7. MIC CONNECTION CONTACTS M- M+

Contacts M- and M+ are used to connect external microphone. Connect white wire to contact M+, black – to M-. In order to avoid interference install microphone as far as possible from GSM antenna. If wire of the MIC is long (over 2 m), it is recommended to use shielded twisted pair cable. Connect shield to GND contact.

## 2.8. RESET CONTACTS

RESET contacts are used to restore factory default parameters (see. ch. 6).

### 3. LED INDICATORS

#### 3.1. NETWORK: INDICATOR OF SIGNAL STRENGTH AND GSM MODULE OPERATION MODE

Indicator state	Explanation
Out.	GSM module is not in use. No power supply or system failure.
Continuously On.	There is no GSM operator network registration. Possible causes: SIM card PIN code request is not deactivated, antenna not connected or poor network connection quality.
Blinking more frequently than once a second.	GSM module is in use: outgoing call or SMS is being sent.
Blinks 5 times, short break after.	Very good signal.
Blinks 4 times, short break after.	Good signal.
Blinks 3 times, short break after.	Satisfactory connection.
Blinks 2 times, short break after.	Weak connection.
Blinks once, short break after.	Poor connection.

#### 3.2. MODE: SYSTEM OPERATION MODE INDICATOR

Indicator state	Explanation
Out.	No power supply or system failure.
Continuously On.	System is operative, disarmed, no zone sensors have been triggered.
On with short breaks.	System is operative, disarmed, but one or more zone sensors have been triggered.
Blinking with low frequency (once in 2-3 sec.).	System is operating in armed mode.
Blinking more frequently than once a second.	System is in alarm state, siren is active, call or SMS is sent. If SMS is sent, indicator blinks a little bit slower (about twice a second).
Blinking very rapidly for 2-3 sec.	SMS instruction or DTMF command receipt confirmation.

#### 3.3. GPRS

In current version (V.3.01) of GsmAlarm-220 GPRS indicator is on, only in case of restoring factory default parameters (see ch. 6).

## 4. INSTALLATION

### 4.1. GENERAL INSTALLATION INSTRUCTIONS

According to manufacturer recommendations, hire qualified security system specialist (or company) to perform system installation works. Self-dependent installation of the system can be performed only if person possess basic knowledge in electricity and electronics, otherwise device might be irrecoverably damaged.

System should be assembled in metal housing 7TRP20 as recommended.

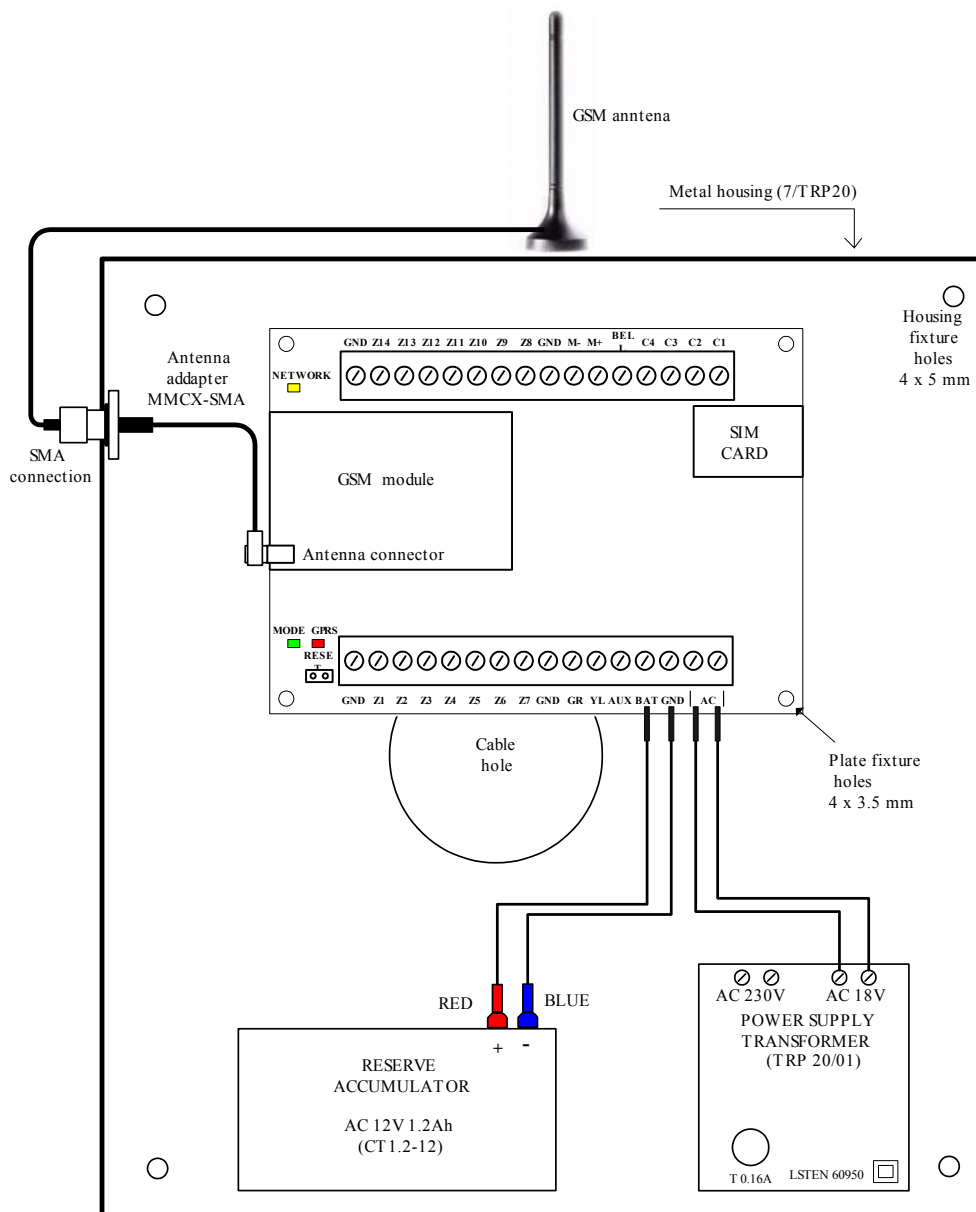

*Recommended layout of system elements in 7/TRP20 type housing*

Use double isolated cable  $3 \times 0,75 \text{ mm}^2$  for 230V power supply. Circuit breaker or other surge protection device should be installed in the 230V power line.

Antenna is fixed on the top of outer side of metal housing.

It is recommended to use standard motion (SRP-300) and fire (EA318-4) sensors in protected zones, use standard 6-8 wired single core cable designed for installation of security systems. Siren DC12V 500mA (S-108) is recommended for sound alarm, use double isolated cable 2x0,75 mm<sup>2</sup> to connect it to the system. Reserve battery must be PB-acid (CT1,2-12).

It is recommended to install remote control relays into sockets which can be easily fixed to metal housing. Operating current of relay coil can not exceed 150mA max. Relays are selected depending on desirable commutative voltage and current.

Use diagram presented in chapter 4.2 to connect system network. It is recommended to install operation mode indicator LED only in case keypad is not used. LED state indicates system operation mode status, if all protected zones are closed before switching on armed mode. *LED* must be installed withindoors in a prominent place.

If keypad is not used system armed mode can be activated or deactivated with short call from user mobile phone (parameter F should be F51 or F41, see ch. 5.3.2.3). Please note, if trying to call the system in alarm state, deactivation is not possible, therefore it is recommended to use switch designed for activation/ deactivation of armed mode. The switch can be connected to any zone instead of sensor contacts. Zone, designated for sensor connection must operate in ON/OFF mode (A33, see ch. 5.3.1.2). Armed mode is activated if there is open circuit in switch contacts. Mode is deactivated by closing circuit in switch contacts.

PARADOX ESPRIT 636, 646 or 642BL keypad can be connected to GsmAlarm-220. *Z15* and *Z16* are keypad zones. Those zones are deactivated if operating in manufacturer programmed parameters (A00, see ch. 5.3.1.2). A parameter must be changed for *Z15* and *Z16* to be active. If using two keypads, input zone configuration of the second keypad jumper must be eliminated; do that, following user manual. Do not change jumper position if keypad zone inputs are not in use.

It is recommended to deactivate the zones which are not in use by changing A parameter value to A00 (see. ch. 5.3.1.2).

SIM card needed for GsmAlarm-220 operation, you may acquire it from any GSM service provider. Before inserting SIM card into GsmAlarm-220 SIM card holder set PIN code request off. It can be performed simply inserting SIM card into any standard mobile phone and following certain phone user manual instructions.

After finishing installation, place SIM card into GsmAlarm-220 SIM card holder, turn system power on, then wait till indicator *NETWORK* will start to blink periodically and indicator *MODE* will be constantly alight. In case *NETWORK* is constantly alight, check if SIM card's PIN code request is off and GSM antenna is connected GSM signal quality can be evaluated according the blinking frequency of *NETWORK* indicator. Connection is very good if it blinks 5 times with short break after. *NETWORK* indicator blinking fewer times, indicates weaker connection. System works in steady state if indicator blinks 3-5 times. Position of GSM antenna might be changed in order to improve signal quality. Perform system programming when armed mode is disabled. Protected zones must be closed (indicator *MODE* constantly alight). Detailed programming process description can be read in chapter 5.

## 4.2. CONNECTION DIAGRAM

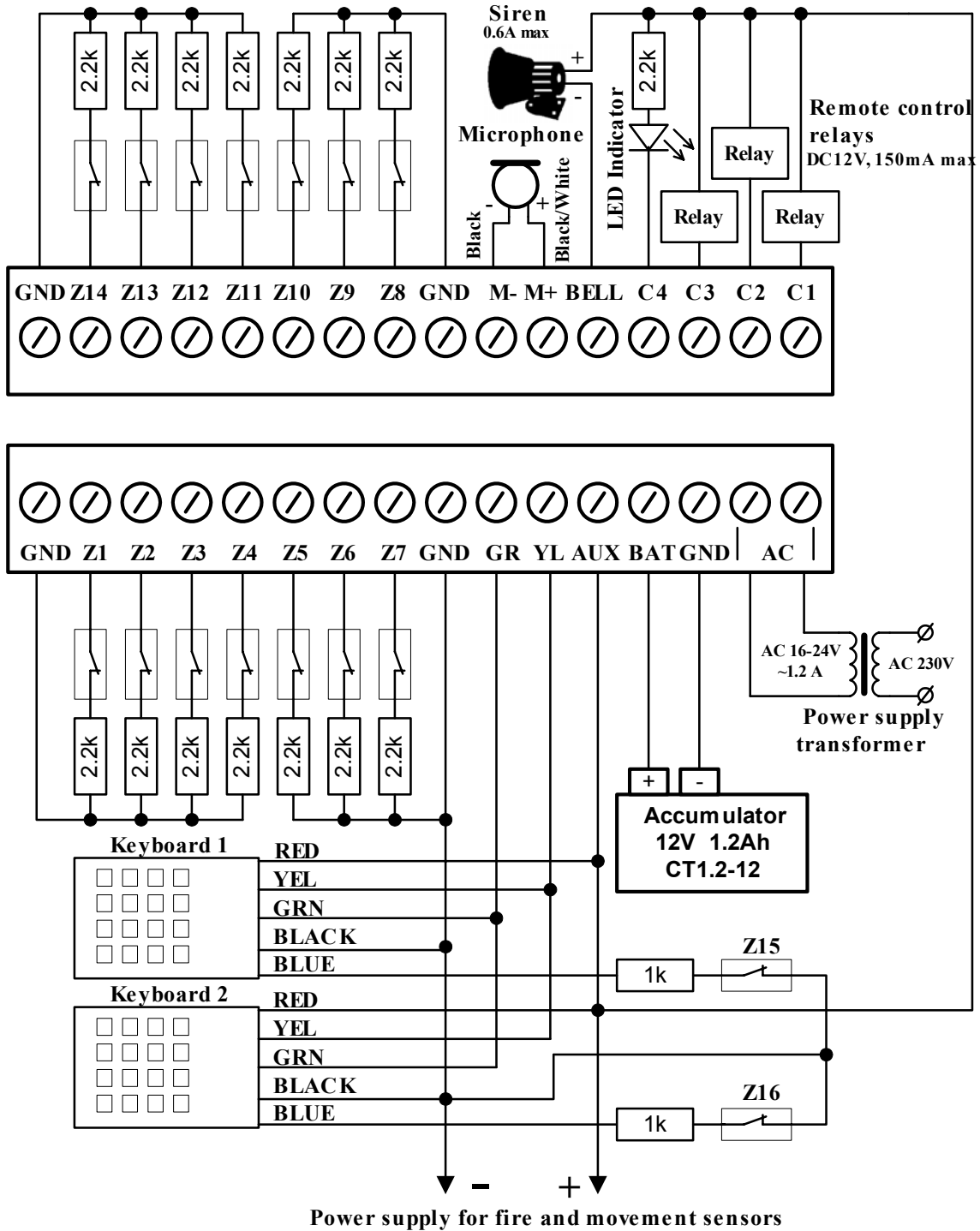

### 4.3. CONNECTION OF TEMPERATURE SENSORS

GsmAlarm-220 has temperature measurement possibility. Up to 14 temperature sensors *KTY81-110* (*PHILIPS*) can be connected to the device.

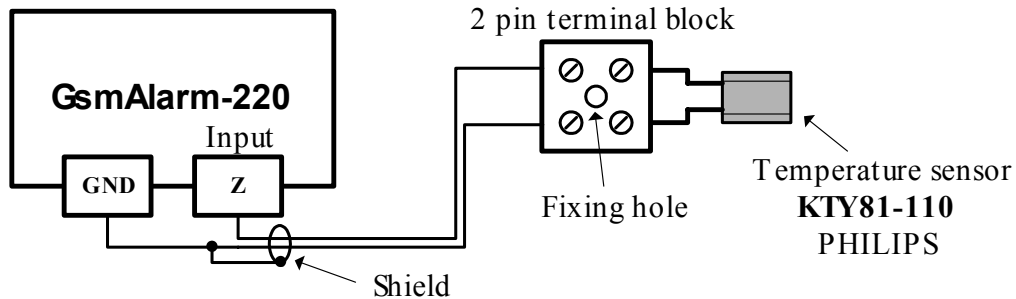

In order to minimise influence of external interferences and measurement error, it is recommended to use shielded twisted pair cable 0.5 mm<sup>2</sup>.

Shield is connected to ground wire only in one end, close to GsmAlarm-220 board. Use pin terminal block with a fixing hole for temperature sensor fastening.

Parameter A must be changed in order to activate temperature measurement mode. (see ch. 5.3.1.2). Input parameter T defines alarm temperature. Alarm temperature can be programmed in 0...+99 °C range (T00 - T99).

In temperature measurement mode input operates the same as in protection mode, i.e. all operation modes are valid with two exceptions:

- a) No delay in *A40 A50*, system operates instantly, after temperature reaches programmed value;
- b) No prohibition for armed mode activation, i.e. user can activate armed mode although temperature measurement zone has been triggered.

Recommended values of parameter M: M40 or M00. In first case, if the system is in armed mode and temperature reaches programmed value, user receives SMS message (siren will not turn On and system will not dial).

Temperature measurement zone can be used as information source in second case. User can send back SMS with information about temperature being measured at his own discretion (see ch. 11).

## 5. PROGRAMMING

### 5.1. GENERAL PROGRAMMING INSTRUCTIONS

GsmAlarm-220 parameters can be divided into two groups. First group – user phone numbers which are stored in SIM card memory. User phone numbers can be programmed by using standard mobile phone of any type (see ch. 5.2.1) or remotely, sending SMS message with the phone numbers of users to GsmAlarm-220 (see ch. 5.2.2).

Second group – parameters, defining system operation algorithms, names of protected zones and programmable outputs. These parameters are stored in the memory block of GsmAlarm-220 device. The parameters of the system can be programmed by sending SMS message (see ch. 5.3) or by using Paradox Esprit keypad (see ch. 5.5).

It is recommended to change the SMS password at the end of programming (see ch. 5.4)

### 5.2. USER NUMBER PROGRAMMING

If GsmAlarm-220 is used for protection, five user numbers can be programmed: *ALRNR1*, *ALRNR2*, *ALRNR3*, *ALRNR4* and *ALRNR5*. These users can arm/ disarm the system, calls will be directed and SMS messages will be sent to these users. If only one user exists, he must be programmed under *ALRNR1*. GsmAlarm-220 will send SMS messages to this specific user in case of main power supply loss or if an unknown number calls the system. If armed mode is turned on or off with the single touch of the keypad or by turning the switch ON/OFF (if the keypad is not used) control dials and SMS messages are also directed to the first user. Other four user numbers are not obligatory.

In case GsmAlarm-220 is used only for gate control it is not necessary to programme *ALRNR1-ALRNR5*. Up to 250 user numbers, with the possibility to control the outputs *C1*, *C2*, *C3*, *C4* and *BELL* with a short call, can be programmed in this case. Any name can be ascribed to user. Output operation mode has to be *M04* or *M05* (see ch. 5.3.2.1).

After programming of user numbers - programme system parameters, names of inputs and outputs (see ch. 5.3).

#### 5.2.1. USER NUMBER PROGRAMMING WITH STANDARD MOBILE PHONE

Insert SIM card into a standard mobile phone. Enter user name into SIM card number book using capital letters e.g. *ALRNR1* and corresponding phone number. We recommend enter the number with international code. (E.g. +370....)

If GsmAlarm-220 is used for gate control, number of extra user numbers can be as large as fits into the SIM card (up to 250). Any name can be ascribed to user.

*Important:*

*It's important to note that while programming SIM card memory should be active (not phone memory!). Otherwise the user number will be recorded in the mobile phone memory used for programming and the SIM card will remain empty.*

After having programmed all user numbers, it is recommended to check whether SMS service centre number is programmed. Simplest way to check: send any SMS from the phone used for programming. If it is sent successfully we can be sure that SMS centre number has been programmed correctly. Otherwise, programme SMS centre number following the mobile phone's user manual. SMS centre number can be learnt from GSM service provider.

After completion of programming and checking whether SIM card PIN code request is switched off, take the SIM card off from the mobile phone and insert it into GsmAlarm-220 SIM card slot.

## 5.2.2. USER NUMBER PROGRAMMING WITH SMS

Switch on the system power source and wait for periodical blinking of *SIGNAL* indicator and *MODE* constantly On.

In order to programme the main user numbers, send the following SMS from any mobile phone into GsmAlarm-220:

```
AAAAAAAA ALRNR1:+3706123456789 ALRNR2:+3706123456789 ALRNR3:+3706123456789  
ALRNR4:+3706123456789 ALRNR5:+3706123456789
```

*AAAAAAAA*: eight digit alphanumeric SMS password, which is obligatory in the beginning of each SMS. Manufacturer-programmed password is *AAAAAAAA*. User can change the password on his own desire (see ch.5.4).

*ALRNR1 ... ALRNR5*: user numbers.

*IMPORTANT:*

- a) *No characters/spaces can be used before the password;*
- b) *No spaces are allowed before and after the colon;*
- c) *Spaces must follow the password and each phone number;*
- d) *It is recommended to enter user numbers with international code (e.g. +123...).*

It is not necessarily to send all user numbers. E.g., in order to programme only the first user number, send the following SMS:

```
AAAAAAAA ALRNR1:+3706123456789
```

Receipt and decrypting of the SMS by GsmAlarm-220 is confirmed by blink of indicator *MODE*. The phone, which has sent the programming SMS, immediately receives a confirming SMS with programmed numbers.

In order to delete unnecessary number, send the following SMS:

```
AAAAAAAA ALRNR2:N
```

Number *ALRNR2* is deleted, user receives SMS with programmed numbers. In order to replace one number with another, no separate instruction for deletion needs to be sent.

In order to receive SMS with programmed numbers *ALRNR1 ... ALRNR5*, send GsmAlarm-220 the following SMS:

```
AAAAAAAA NRINFO
```

Extra user numbers (only for gate control) are programmed by sending the following SMS:

*AAAAAAAA ADDNR:+3701234567891 ADDNR:+3701234567892 ADDNR:+3701234567893*

*ADDNR:* – new number entering instruction.  
*+3701234567891* – new user number.

Up to 8 user numbers might be programmed with one SMS message.

If number was programmed successfully, the user, who sent the message, receives SMS with newly programmed number. In this case the confirmation message will be:

*USR1:+3701234567891 USR2:+3701234567892 USR3:+3701234567893*

*USR1* – name, assigned to the new number.

In order to delete the extra user number, send to GsmAlarm-220 the following message:

*AAAAAAAA DELNR:+3701234567891 DELNR:+3701234567892 DELNR:+3701234567893*

Specified numbers will be deleted and user receives the confirming SMS:

*DELET:+3701234567891 DELET:+3701234567892 DELET:+3701234567893*

Up to 8 user numbers might be deleted with one SMS message.

In order to receive SMS message indicating all programmed numbers, following message must be sent to GsmAlarm-220:

*AAAAAAAA NRLIST*

User receives one or more SMS messages with all programmed numbers listed.

*Note! Up to 8 user numbers can be sent in one SMS message. If 250 numbers are programmed GsmAlarm-220 will send 32 SMS messages!*

### 5.3. SYSTEM PARAMETER PROGRAMMING WITH SMS

All GsmAlarm-220 input and output operation modes, delay times and names can be programmed with the help of SMS. First of all, it is recommended to receive SMS with programmed parameters and then to send the same SMS with corrected parameters back to GsmAlarm-220.

#### 5.3.1. PROTECTED ZONES Z1-Z16 PARAMETER PROGRAMMING

In order to receive SMS with input Z1 - Z16 parameters, send GsmAlarm-220 the following SMS:

*AAAAAAAA ZPARAM*

SMS can be sent from any GSM phone, not necessarily the user's. GsmAlarm-220 confirms receiving the message with frequent blinking of MODE indicator and sends three SMS messages including input parameters Z1- Z16. First message contains Z1 - Z5 parameters, second - Z6 - Z10 and Z11 - Z16 parameters in third SMS message. Received message with input Z1 – Z5 parameters will look as follows:

*AAAAAAAA Z01:M70T20A30 Zone1, Z02:M70T00A30 Zone2, Z03:M70T00A30 Zone3,  
Z04:M70T00A30 Zone4, Z05:M70T00A30 Zone5,*

*AAAAAAAA:* password.

*Z1:* protected zone input number.

*M70:* parameter defines system response to the violation of protected zone and which users are informed if certain zone sensors are triggered (see ch. 5.3.1.1.).

*T20:* delay time after triggering (in seconds), if system is in armed mode. After relevant input is triggered, the system switches siren on and sends SMS only after expiration of the given delay time. Possible values: 0...99 seconds.

If zone is in temperature measurement mode, value of T parameter corresponds to triggering temperature (see ch. 5.3.1.2). Possible values: 0...99 °C.

*A30:* input operation mode, parameter A (see ch. 6).

*Zone1, Zone2, Zone3, Zone4, Zone5:* input names, which are seen in the SMS after alarm triggering. User can change the name of zone under his own discretion. Maximum number of name characters: 11.

### 5.3.1.1. PARAMETER M

Alarm state after input triggering	MXY		Users, getting information about zone violation
	X	Y	
All functions, described below, are deactivated.	0	0	All (ALRNR1-ALRNR5).
Siren is operating.	1	1	Only user ALRNR1.
Calling.	2	2	Only user ALRNR2.
Siren is operating and calling.	3	3	Only user ALRNR3.
Sending SMS message.	4	4	Only user ALRNR4.
Siren is operating and sending SMS message.	5	5	Only user ALRNR5.
Calling and sending SMS message.	6	6	Users ALRNR1 and ALRNR2.
Siren is operating, calling and sending SMS message.	7	7	Users ALRNR1, ALRNR2 and ALRNR3.
-	-	8	Users ALRNR1, ALRNR2, ALRNR3 and ALRNR4.

### 5.3.1.2. PARAMETER A

Input triggering conditions	AXY		Input operation mode
	X	Y	
Input disabled.	0	0	Input with programmable delay time. *
Zero-one mode, active level: low (GND).	1	1	24 hour input. **
Zero-one mode, active level: high (+12V or open contact).	2	2	Fire sensor connection input ***
Loaded input mode, 2.2k load required.	3	3	ON/OFF zone. ****
Temperature measurement mode. Alarm is activated if measured temperature overcomes programmed temperature T.	4	-	
Temperature measurement mode. Alarm is activated if measured temperature is lower than programmed temperature T.	5	-	

\* *Input with programmable delay time.* After relevant zone is being triggered, the system will switch alarm on only if armed mode is active, after expiration of the given delay time T.

\*\* *24 hour input.* After relevant zone is being triggered, the system switches alarm on with no respect to armed mode (ON/OFF), siren operates constantly, delay time is ignored.

\*\*\* *Fire zone mode.* 24 hour input, siren is operating with interruptions.

\*\*\*\* *Zone ON/OFF.* Mode designated to turn armed mode on/off if keypad is not used.

### 5.3.2. PROGRAMMING OF OUTPUT C1-C4, BELL AND COMMON SYSTEM PARAMETERS E, F, T

In order to receive SMS message including output *C1-C4*, *BELL* and common system parameters, send *GsmAlarm-220* the following message:

*AAAAAAAA CPARAM*

Receiving the message is confirmed by blinking of indicator *MODE* of *GsmAlarm-220* device, SMS with current system parameters is being sent:

*AAAAAAAA C1:M01T00 OutC1, C2:M01T05 OutC2, C3:M05T05 OutC3, C4:M02T05 OutC4, C5:M06T02 Siren, P01:E20F51T20,*

*C1*: number of programmable output. *C5* corresponds to siren output *BELL*.

*M01*: output operation mode (see ch. 5.3.2.1.)

*T00*: output operation time. Outputs *C1-C4*: in seconds, *C5 (BELL)*: in minutes.

*OutC1, OutC2, OutC3, OutC4* and *Siren*: programmable output names. User can change the name under his own discretion. Maximum number of name characters: 11.

*P01*: command for common system parameters programming.

*E20*: method to inform user about armed mode activation/deactivation. User can be informed by short call or SMS message. (see ch. 5.3.2.2.)

*F31*: system response to incoming/outgoing calls and number of calls in alarm state. (see ch. 5.3.2.3.)

*T20*: delay time after armed mode activation. Possible values: 00 – 99 seconds.

### 5.3.2.1. OUTPUT C1-C4, BELL OPERATION MODE

Output mode	Explanation of operation
M00	Not in use.
M01	Output controlled by DTMF or SMS instructions. If zero operation time is programmed (T00), output is activated/deactivated and remains in the same state after receiving DTMF or SMS instruction. If not zero operation time is programmed, after receiving DTMF or SMS instruction, output is activated, it deactivates automatically after expiration of the programmed time.
M02	LED mode. Output is in operation together with MODE indicator.
M03	Output is activated, when system is armed. Open contact, when system is disarmed.
M04	Control by short call without number recognition function. Output is activated with a call from any number. If zero operation time is programmed (T00), output state changes after a call and remains unchanged till the next short call. If not zero operation time is programmed, after receiving short call instruction output is activated, it deactivates automatically after expiration of the programmed period.
M05	Control by short call with number recognition function (gate control mode). This mode operates analogue to M04, thus it is activated only if short call number coincides with programmed numbers.
M06	Siren mode. Valid only for output BELL (C5).
M07	Siren mode with audible confirmation. After arming, one short audible sound is heard. After disarming, two short audible sounds are heard. Valid only for output BELL (C5).
M11	Output activates, zone triggered Z1. *
M12	Output activates, zone triggered Z2. *
M13	Output activates, zone triggered Z3. *
M14	Output activates, zone triggered Z4. *
M15	Output activates, zone triggered Z5. *
M16	Output activates, zone triggered Z6. *
M17	Output activates, zone triggered Z7. *
M18	Output activates, zone triggered Z8. *
M19	Output activates, zone triggered Z9. *
M20	Output activates, zone triggered Z10. *
M21	Output activates, zone triggered Z11. *
M22	Output activates, zone triggered Z12. *
M23	Output activates, zone triggered Z13. *
M24	Output activates, zone triggered Z14. *
M25	Output activates, zone triggered Z15. *
M26	Output activates, zone triggered Z16. *

\* If zero operation time is programmed (T00), output is activated when adequate zone is triggered (open) and deactivated when adequate zone is not triggered (close). If not zero delay time is programmed, output is activated automatically when adequate zone is triggered and deactivates automatically after expiration of the programmed time *T*.

Outputs are controllable when armed mode is on/off.

**5.3.2.2. PARAMETER E : INFORMING USER ABOUT ARMING/DISARMING MODE**

System response to switching the armed mode ON	EXY		System response to switching the armed mode OFF
	X	Y	
All functions below are deactivated.	0	0	All functions below are deactivated.
User is informed by SMS.	1	1	User is informed by SMS.
User is informed with a short call.	2	2	User is informed with a short call.
User is informed with a short call and SMS message.	3	3	User is informed with a short call and SMS message.

**5.3.2.3. PARAMETER F : SYSTEM RESPONSE TO INCOMING CALLS AND NUMBER OF CALLS IN ALARM MODE**

System response to incoming call*	FXY		Number of the calls in alarm mode
	X	Y	
All functions below are deactivated.	0	0	-
If a call is received from unknown caller, user ALRNR1 will receive a SMS with caller's number.	1	1	After alarm triggering, users will be called once.
If calling from user's number, after 3-4 calls the system will pick up, armed mode will remain on.	2	2	Users are called twice.
Armed mode is activated after user's short call.	4	3	Users are called 3 times.

*Note! If several functions have to be operative, sum of the numbers is used.  
E.g.: for all three X functions to be active, X value must be 7 (1+2+4=7).*

### 5.3.3. SYSTEM CLOCK SETTING

System's clock should be set only if timer function is used. In order to set system clock time (E.g. 12: 45 p.m.), following SMS must be sent to GsmAlarm-220:

*AAAAAAAA SCLOCK:12-45*

*AAAAAAAA* password;  
*SCLOCK:* time set instruction;  
*12-45* time (12: 45 p.m.).

Check up of programmed system time can be preformed by sending following SMS to GsmAlarm-220:

*AAAAAAAA SCLOCK*

GsmAlarm-220 sends back SMS with programmed system time to the specific user.

### 5.3.4. 24 HOUR TIMER SETTING

Timer function enables activation/ deactivation of programmable output and armed mode, sending SMS message, etc. on a desired time.

It is recommended to receive SMS message with programmed timer parameters. To do that, following SMS message must be sent to GsmAlarm-220:

*AAAAAAAA STIMER*

GsmAlarm-220 sends back message with current timer parameters to user:

*AAAAAAAA TMR01:00,00-00 TMR02:00,00-00 TMR03:00,00-00 TMR04:00,00-00 TMR05:00,00-00  
TMR06:00,00-00 TMR07:00,00-00 TMR08:00,00-00 TMR09:00,00-00 TMR10:00,00-00*

*AAAAAAAA* password;

*TMR01...TMR10* number of timer event. 10 independent timer events can be programmed.

*:00,* timer instruction, defining which function should be performed in programmed time.  
Please read detailed description of timer instructions in paragraph 5.3.4.1.

*00-00* timer activation time.

Renewed SMS message has to be sent to GsmAlarm-220. User receives SMS message with newly programmed parameters after.

*Examples for programming.*

For the system to activate input C2 12: 30 p.m., deactivate 13: 00 p.m. and 13: 01 p.m. and to send SMS message, informing about the state of outputs, following SMS has to be sent to GsmAlarm-220:

*AAAAAAAA TMR01:22,12-30 TMR02:20,13-00 TMR03:77,13-01*

### 5.3.4.1. TIMER INSTRUCTIONS

Timer instruction	Designation
00	Timer OFF.
01	Armed mode activation.
02	Armed mode deactivation.
11	Output C1 activated.
10	Output C1 deactivated.
22	Output C2 activated.
20	Output C2 deactivated.
33	Output C3 activated.
30	Output C3 deactivated.
44	Output C4 activated.
40	Output C deactivated.
55	Output BELL activated.
50	Output BELL deactivated.
77	Request to send SMS message with information about output state.
88	Request to send SMS message with information about connection quality and power supply voltage.
99	Request to send SMS message with information about state of protected zones.

*Note! SMS messages could be sent only to user ALRNR1.*

### 5.4. SMS PASSWORD CHANGE

In order to change manufacturer-programmed SMS password, send GsmAlarm the following message:

*AAAAAAAA PASSW:ABCDefgh*

*AAAAAAAA* – old SMS password.

*PASSW* – password changing instruction.

*ABCDefgh* – new SMS password. Password must be 8 characters long!

*Note!*

*No characters/spaces can be used before password, space must follow the password.*

If programming instruction is executed successfully, user gets a confirming SMS message with the new SMS password.

## 5.5. PROGRAMMING USING *PARADOX ESPRIT* KEYPAD

All system parameters, except for user phone numbers and names of protected zones and programmable outputs, are programmable using keypad. User numbers are programmed only by sending SMS message or by method described in ch. 5.2.1, names – SMS message only.

Programming mode is activated by pressing keypad key *ENTER* and entering 4 or 6 digit administrator code (default (manufacturer assigned) code: 0000). *ENTER* key blinks periodically in programming mode. Two digit address of parameter to be programmed should be entered next. After typing address (*ENTER* key constantly On), 2 or 4 (6) digit programmable parameter should be entered. If, after entering the address, *2ND* key is constantly On – system is ready to accept 2 digit parameter. If, after entering the address, *2ND* key blinks periodically or no light On – system is ready to accept 4 or 6 digit user code. Acceptance of parameter entered is confirmed with three short audible signals. Press *CLEAR* key to exit programming mode.

### 5.5.1. USER CODE PROGRAMMING

Programming mode is activated by pressing *ENTER* key and entering administrator code (manufacturer programmed administrator code: 0000). Enter corresponding user address when *ENTER* key blinks constantly. If *2ND* blinks periodically after address is entered, system is ready for new user code to be programmed. If there is no light on *2ND* key, space is already occupied with user code. Newly entered user code will replace previous in this case. Old user code can be erased by pressing *2ND* after entering address. If *2ND* starts to blink periodically – old code is erased.

Maximum number of users, able to control system with keypad: 10.

Table below describes which user will be informed about arming/ disarming the system with a short call or SMS message.

Address	User code	Which user will be informed about arming/ disarming the system
00	Administrator code.	ALRNR1
01	First user code.	ALRNR1
02	Second user code.	ALRNR2
03	Third user code.	ALRNR3
04	Forth user code.	ALRNR4
05	Fifth user code.	ALRNR5
06	Sixth user code.	ALRNR1
07	Seventh user code.	ALRNR1
08	Eighth user code.	ALRNR1
09	Ninth user code.	ALRNR1

### 5.5.2. DELAY TIME AFTER ARMING/ DISARMING

After giving instruction to activate armed mode it will be active only when programmed time will pass.

Possible values: 00 – 99 seconds.

Address	Parameter
30	Armed mode activation delay time

Manufacturer-programmed delay time: 20 seconds.

### 5.5.3. PARAMETER T: DELAY TIME OF Z1-Z16 ZONES OR TRIGGERING TEMPERATURE

If input zone operates in protection mode, after relevant zone is triggered, the system switches siren on and sends SMS only after expiration of the given delay time T. Possible values: 0...99 seconds.  
If zone operates in temperature measurement mode, value of T parameter corresponds to triggering (alarm activation) temperature. Possible values: 0...99 °C.

Address	Parameter
11	Zone Z1 „T“ parameter
12	Zone Z2 „T“ parameter
13	Zone Z3 „T“ parameter
14	Zone Z4 „T“ parameter
15	Zone Z5 „T“ parameter
16	Zone Z6 „T“ parameter
17	Zone Z7 „T“ parameter
18	Zone Z8 „T“ parameter

Address	Parameter
19	Zone Z9 „T“ parameter
20	Zone Z10 „T“ parameter
21	Zone Z11 „T“ parameter
22	Zone Z12 „T“ parameter
23	Zone Z13 „T“ parameter
24	Zone Z14 „T“ parameter
25	Zone Z15 „T“ parameter
26	Zone Z16 „T“ parameter

Manufacturer-programmed time for zone Z1: 20 seconds, zones Z2-Z16: 00 seconds.

### 5.5.4. PARAMETER A: OPERATION MODES OF ZONES Z1-Z16

Parameter A defines system's input operation modes and is described in detail in chapter 5.3.1.2.

Address	Parameter
51	Zone Z1 „A“ parameter
52	Zone Z2 „A“ parameter
53	Zone Z3 „A“ parameter
54	Zone Z4 „A“ parameter
55	Zone Z5 „A“ parameter
56	Zone Z6 „A“ parameter
57	Zone Z7 „A“ parameter
58	Zone Z8 „A“ parameter

Address	Parameter
59	Zone Z9 „A“ parameter
60	Zone Z10 „A“ parameter
61	Zone Z11 „A“ parameter
62	Zone Z12 „A“ parameter
63	Zone Z13 „A“ parameter
64	Zone Z14 „A“ parameter
65	Zone Z15 „A“ parameter
66	Zone Z16 „A“ parameter

Manufacturer-programmed values for zones Z1-Z14: 30, and zones Z15, Z16: 00.

### 5.5.5. PARAMETER M: OPERATION MODES OF ZONES Z1-Z16

Parameter M defines system response to the violation of protected zone and which users are informed if certain zone sensors are triggered. It is described in detail in chapter 5.3.1.1.

Address	Parameter
71	Zone Z1 „M“ parameter
72	Zone Z2 „M“ parameter
73	Zone Z3 „M“ parameter
74	Zone Z4 „M“ parameter
75	Zone Z5 „M“ parameter
76	Zone Z6 „M“ parameter
77	Zone Z7 „M“ parameter
78	Zone Z8 „M“ parameter

Address	Parameter
79	Zone Z9 „M“ parameter
80	Zone Z10 „M“ parameter
81	Zone Z11 „M“ parameter
82	Zone Z12 „M“ parameter
83	Zone Z13 „M“ parameter
84	Zone Z14 „M“ parameter
85	Zone Z15 „M“ parameter
86	Zone Z16 „M“ parameter

Manufacturer-programmed values for all zones: 70.

### 5.5.6. OPERATION TIME OF OUTPUTS C1-C4 AND BELL

Output operation time if output operates in impulse mode. Possible values: 00-99.

Address	Parameter
31	Operation time of output C1, seconds.
32	Operation time of output C2, seconds.
33	Operation time of output C3, seconds.
34	Operation time of output C4, seconds.
35	Operation time of siren BELL (C5), minutes.

Manufacturer-programmed time: C1:00 sec., C2:05 sec., C3:05 sec., C4:05 sec., BELL: 02 min.

### 5.5.7. OPERATION MODE OF OUTPUTS C1-C4 AND BELL

Possible operation modes are described in detail in chapter 5.3.2.1.

Address	Parameter
91	Operation mode of output C1.
92	Operation mode of output C2.
93	Operation mode of output C3.
94	Operation mode of output C4.
95	Operation mode of output BELL (C5).

Manufacturer-programmed output modes: C1-01, C2-01, C3-05, C4-02, C5-06.

### 5.5.8. COMMON SYSTEM PARAMETERS, PARAMETER „E“

Parameter „E“ defines the way user is informed about arming mode activation/deactivation. It is described in detail in chapter 5.3.2.2.

Address	Parameter
96	System parameter „E“.

Manufacturer-programmed value: 20.

### 5.5.9. COMMON SYSTEM PARAMETERS, PARAMETER „F“

Parameter „E“ defines system response to incoming calls and number of calls to user, in case of alarm. It is described in detail in chapter 5.3.2.3.

Address	Parameter
97	System parameter „F“.

Manufacturer-programmed value: 31.

### 5.5.10. PARTIAL PROTECTION MODES „STAY“ AND „AWAY“

Security system can operate in full or partial protection modes. In case of full protection mode all zones are protected. If partial control mode is activated, only some of zones are protected. Partial protection mode is activated by pressing *STAY* or *AWAY* keys (*FORCE*, in case LCD keypad ESPRIT 642 is used) and entering user code afterward.

To configure the system for partial protection, *BYPASS* mode should be activated by pressing *BYP* key and entering user code, (*BYP* key starts to blink periodically). Pressing key, relative to certain zone number, corresponding zone can be activated or deactivated. If key LED is on – zone deactivated, key LED off – zone is activated. Zones Z13-Z16 can be activated or deactivated by pressing *2ND* key. *2ND* key starts to blink periodically, keypad key 1 indicates zone Z13, key 2 – zone Z14, key 3 – zone Z15, key 4 – zone Z16.

After configuration, press *EXIT* key to exit *BYPASS* mode. Programming mode is activated by pressing *ENTER* key and entering administrator code afterwards.

Entering address **28**, *BYPASS* configuration for partial protection mode “*STAY*”.

Entering address **29**, *BYPASS* configuration for partial protection mode “*AWAY*”.

### 5.5.11. AUDIBLE INDICATION FOR DELAY TIME

When armed mode is activated, delay time count can be indicated by short audible keypad signals, repeating each second.

Address	Parameter value	Explanation
27	00	Audible indication OFF
27	01	Audible indication ON

Manufacturer-programmed value: 00.

### 5.5.12. USER CODE LENGTH (4 OR 6 DIGITS)

Address	Parameter value	Explanation
10	04	Four digit user code
10	06	Six digit user code

Manufacturer-programmed value: 04.

### 5.5.13. SYSTEM CLOCK SETTING

System's clock should be set only timer function is used. In order to set system clock time, press *ENTER* key and enter administrator code, programming mode then is activated (*ENTER* key is blinking). Press *MEM* key after, (*ENTER* LED is on constantly) system time in 24 hour format entered. E.g.: to programme 14: 35 p.m. system time, press keys 1, 4, 3, 5. Programming mode is deactivated by pressing *CLEAR* key.

#### 5.5.14. SYSTEM TIMER PROGRAMMING

User is able to programme up to 10 independent timer events. Each event is definable with event number, instruction and event time. Address, given in the table bellow, indicates event number. Event instruction indicates function to be performed in programmed time (E.g. SMS message to be sent, related output activated/ deactivated etc.). Event commands are described in chapter 5.3.4.1.

In order to programme timer event programming mode should be activated (*ENTER* + administrator code). After, address, indicating event number, has to be entered ( *ENTER* key LED constantly On) and six digit sequence. First two digits – event instruction; where following four – timer activation time.

E.g.: for output C2 to be activated at 12: 15 p.m., begin entering address *41* (event TMR01), then enter: *22 12 15* (22 – output C2 activation code, 12 15 – activation time).

Address	Timer event number
41	TMR01
42	TMR02
43	TMR03
44	TMR04
45	TMR05
46	TMR06
47	TMR07
48	TMR08
49	TMR09
50	TMR10

## 6. RESETTING SYSTEM PARAMETERS TO FACTORY DEFAULTS

In order to reset all system parameters to factory default settings, disconnect system power supply and reserve battery, short contacts RESET and connect system power supply.

When MODE and GPRS indicators are off (wait 2-3 seconds to pass), shorter may be removed. System parameters are set to values denoted in chapter 6.1.

Only the parameters stored in the internal memory module system can be reprogrammed using this method. User numbers stored in SIM card will not be erased.

### 6.1. MANUFACTURER PROGRAMMED PARAMETERS

Input parameters				
Input	Name	Parameter <i>M</i>	Parameter T, sec.	Parameter <i>A</i>
Z1	Zone1	M70	T20	A30
Z2	Zone2	M70	T00	A30
Z3	Zone3	M70	T00	A30
Z4	Zone4	M70	T00	A30
Z5	Zone5	M70	T00	A30
Z6	Zone6	M70	T00	A30
Z7	Zone7	M70	T00	A30
Z8	Zone8	M70	T00	A30
Z9	Zone9	M70	T00	A30
Z10	Zone10	M70	T00	A30
Z11	Zone11	M70	T00	A30
Z12	Zone12	M70	T00	A30
Z13	Zone13	M70	T00	A30
Z14	Zone14	M70	T00	A30
Z15	Zone15	M70	T00	A00
Z16	Zone16	M70	T00	A00
Output parameters				
Output	Name	Parameter <i>M</i>	Operation time T	
C1	OutC1	M01	T00 (sec.)	
C2	OutC2	M01	T05 (sec.)	
C3	OutC3	M05	T05 (sec.)	
C4	OutC4	M02	T05 (sec.)	
C5 (BELL)	Siren	M06	T02 (min.)	
Common system parameters				
SMS Password	Parameter <i>E</i>	Parameter <i>F</i>	T, delay time after arming of the system	
AAAAAAAA	E20	F31	T20 (sec.)	

## 7. SYSTEM CONTROL USING PARADOX ESPRIT KEYPAD

Using the keypad users can activate/ deactivate full or partial protection mode, turn off armed mode, and configure system parameters. By following keypad LED indicators, you can determine protected unit state, system mode.

### 7.1. KEYPAD KEYS FUNCTION

#### 7.1.1. 2ND KEY

*2ND* key intended for additional keypad indication mode activation. If in base indication mode, keypad keys 1-12 LED light is constantly on, then the zone, indicated by alight key number, is open (triggered). E.g.: if zone Z1 is open, key 1 is alight. If zone Z12 is open, keypad number 12 is alight.

If *2ND* key is constantly on it indicates some open zones Z14 - Z16. Pressing *2ND* key, additional indication mode being activated (*2ND* blinks periodically). Zone Z13 is indicated by key number 1, Z14 – number 2, Z15 – number 3 and Z16 – number 4. To deactivate *2ND* mode, press *2ND* key one more time or press *CLEAR*.

#### 7.1.2. TBL KEY

If key *TBL* alight, it indicates system failure. Press *TBL* to check the failure type. *TBL* starts to blink periodically and alight key numbers indicate failure type.

Alight key	Failure
1	No reserve battery connection, or low power reserve battery.
2	AC power failure.
8	System clock loss. *
10	GSM connection failure.
11	Fire alarm sensor wiring failure.

To deactivate *TBL* mode, press *TBL* key one more time or press *CLEAR* key.

\* System's clock should be set only system timer function is used. System clock deregulates in case main power supply and reserve batteries are disconnected. System clock setting with SMS message directions described in chapter 5.3.3. System clock setting with keypad described in chapter 5.5.13.

#### 7.1.3. MEM KEY

After system triggering, system memorises triggered zone (zones) number. If triggered zone's memory is not empty, *MEM* key constantly on. Memory indication mode is activated by pressing *MEM* key (*MEM* starts to blink periodically). Alight numbers indicate which zone had been triggered.

Memory is erased automatically when armed mode is activated or by pressing *CLEAR* key when memory indication mode is active.

#### **7.1.4. BYP KEY**

Sensor of some zone is broken, failed zone can be deactivated using BYPASS function. BYPASS function is activated by pressing *BYP* key and entering 4 or 6 digit user code. *BYP* key starts to blink periodically. Zone can be deactivated by pressing number key, indicating certain zone number. Constantly alight key indicates of certain zone as not active. To activate zone, press number key, indicating certain zone number one more time. Press *CLEAR* key to turn off BYPASS programming mode. System memorizes deactivated zones. Constantly alight keypad key *BYP* indicates, there are some deactivated zones in system memory. BYPASS memory is erased automatically when armed mode is deactivated.

#### **7.1.5. CLEAR KEY**

*CLEAR* key is used to clear mistakes when entering user code (etc.) or to return to main keypad mode.

#### **7.1.6. ENTER KEY**

Use *ENTER* key to activate system parameter programming mode.

### **7.2. FULL PROTECTION MODE ACTIVATION**

All zones are protected when full protection mode is active. Armed mode can be activated only in case all protected zones are closed (not triggered) and green indicator *READY* is on. Constantly alight keypad key numbers indicate corresponding open (triggered) zones (number 1 – zone Z1, number 12 – zone Z12). Full protection mode is activated, entering 4 or 6 digit code. When right code is entered, indicator *ARMED* lights on and system starts counting zone exit time. Output delay time count is indicated by periodically blinking indicator LED and short, repeating each second, audible keypad signals.

After expiration of delay time, system armed mode activates, user receives confirmation short call or SMS message (depends on system configuration, see ch. 5.3.2.2.)

### **7.3. PARTIAL PROTECTION MODE ACTIVATION**

If partial control mode is activated, only several of zones are protected (E.g.: someone is inside of the house, doors and windows have to be protected but motion sensors have to be ignored). Partial protection mode is activated by pressing *STAY* or *AWAY* keys (*FORCE*, in case LCD keypad ESPRIT 642 is used) and entering user code afterwards. Partial protection mode can be activated by pressing one key. Press-and-hold key *AWAY* or *STAY* for 3 seconds to activate armed mode, user ALRNR1 receives confirmation short call or SMS message in this case. Constantly alight *STAY* and *AWAY* keys indicate of partial protection mode.

Partial protection mode is invalid for zones operating in 24 hour mode.

### **7.4. ARMED MODE DEACTIVATION**

Armed mode deactivates, when 4 or 6 digit user code is entered. Certain time period (programmed by installer) is reserved for code entering. If after certain time code is not entered, system switches to alarm mode – turns siren on, calls and sends SMS message.

## 7.5. REMOTE ARMING AND DISARMING

Full protection mode can be activated or deactivated remotely. In order to switch the armed mode on, user calls GsmAlarm-220 number, after system takes the call, using phone keypad, code **01\*** must be entered. Call is cancelled automatically; user receives a short confirmation call or SMS. If system is activated remotely, output delay time is 5 seconds. To switch off armed mode, user calls GsmAlarm-220 number, after system takes the call, using phone keypad, code **00\*** must be entered. Call is cancelled automatically; user receives a short confirmation call or SMS.

## 8. SYSTEM CONTROL, WHEN KEYPAD IS NOT USE

In case keypad is not used GsmAlarm-220 armed mode can be switched on using ON/OFF switch or remotely, using mobile phone.

### 8.1. CONTROL USING *ON/OFF* SWITCH

Armed mode can be activated only in case all protected zones are closed (not triggered) and indicator *MODE* constantly on.

After breaking *ON/OFF* switch contacts, switch-on delay time is started to countdown (*MODE* LED is blinking). If after expiration of the delay period, all zones are not triggered, the system enters armed mode, user *ALRNR1* receives a short confirmation call or SMS. Don't cancel the confirmation call because it is cancelled automatically.

Switch the armed mode off, by connecting switch contacts. If system is inactive and 24-hour zone is triggered, switch the siren off and cancel calling by putting the *ON/OFF* switch into open contacts position and, after 2-3 seconds, returning to closed contacts position.

### 8.2. REMOTE CONTROL

Armed mode can be activated by short, free call. In order to switch the armed mode on, user calls GsmAlarm-220 number and, hearing the first signal, cancels the call. In this case no switch-on delay time is countdown. After the armed mode is on, user receives a short confirmation call or SMS. Don't cancel the confirmation call because it is cancelled automatically.

Switch the armed mode off by calling GsmAlarm-220 number and waiting for the system cancels the call (3-4 call signals).

Check whether the alarm is operating by short call to GsmAlarm-220 number. If GsmAlarm-220 is in operation, user receives a short confirmation call.

## 9. SYSTEM OPERATION IN ALARM MODE

After protected zone being triggered and expiration of delay time, system switches to alarm mode: depending on the programmed system operation algorithm, switches the siren on and calls ALRNR1-ALRNR5 users or sends SMS messages in turn. If system programmed to call and to send SMS messages, at the end of the call cycle (no user picks up the prone) SMS message, with name of triggered zone and number of triggers, will be sent to all users. If whichever user picks up, and enters any DTMF instruction using his phone keypad (see ch. 11), SMS messages won't be sent to other users. If user which answers the phone will enter DTMF instruction, SMS message will be sent to all users. Example of the message, user receives, given bellow:

*SYSTEM ARMED. STAY MODE. DOOR: ALR(1) MOTION:OK(5)*

Received SMS message contains informs that armed mode is on, system operates in partial protection mode *STAY*, door and motion sensors are triggered. *ALR* symbol next to zone name indicates alarm

mode (ALARM) was active when SMS was sent. Number in brackets indicates number of certain zone triggers. Word OK refers that zone was closed but alarmed for short period, in moment SMS message was sent. Resetting of trigger counter to zero value can be done by activating / deactivating armed mode.

User, who answers the call, can hear what is going on in relative zone and control system with DTMF instructions by entering code consisting from two digits and asterisk.

If zone, operating in temperature measurement mode is triggered, user will see measured temperature value next to zone name:

*SYSTEM ARMED. STAY MODE. ZONE\_1:T=19C*

## **10. INFORMING THE USER ABOUT POWER SUPPLY FAILURE**

In case of main power supply failure after 20 seconds user *ALRNRI* receives following SMS message:

*Power:NO, Battery:12.5V, Signal strength: 100%*

In case of upstart of power supply voltage after 20 seconds user *ALRNRI* receives following SMS message:

*Power:YES, Battery:13.7V, Signal strength: 100%*

Message is sent only when armed mode is on.

## 11. CONTROL USING DTMF AND SMS INSTRUCTIONS

In the speech mode user can control the system, after having entered relevant code from his phone keypad. Instruction consists of two digits; it is entered by pressing asterisk key. If the instruction is completed, user hears three tone confirmation signals.

Speech mode can be activated in two ways: user answers when GsmAlarm-220 calls, or user calls and waits for GsmAlarm-220 to answer (3-4 call signals).

The control instructions may be given by SMS. Insert password in the beginning, then type the instruction. E.g.: in order to switch on commutator *C1*, to switch off commutator *C2*, to switch on *BELL* and to receive a SMS with information on the status of the protected site, send the following SMS : *AAAAAAA 11\* 20\* 55\* 77\**

DTMF or SMS instruction	Result
<i>00*</i>	System disarming.
<i>01*</i>	System arming.
<i>11*</i>	Activating output <i>C1</i> .
<i>10*</i>	Deactivating output <i>C1</i> .
<i>22*</i>	Activating output <i>C2</i> .
<i>20*</i>	Deactivating output <i>C2</i> .
<i>33*</i>	Activating output <i>C3</i> .
<i>30*</i>	Deactivating output <i>C3</i> .
<i>44*</i>	Activating output <i>C4</i> .
<i>40*</i>	Deactivating output <i>C4</i> .
<i>55*</i>	Activating output <i>BELL</i> .
<i>50*</i>	Deactivating output <i>BELL</i> .
<i>77*</i>	Request to send SMS about state of the system outputs.
<i>88*</i>	Request to send SMS with information about GSM signal strength and power supply voltage.
<i>99*</i>	Request to send SMS about state of the system and protected zones.

SMS and DTMF control instructions

SMS instruction	Result
<i>ZPARAM</i>	Request to send SMS message with input Z1-Z5 parameters.
<i>CPARAM</i>	Request to send SMS message with output C1, C2 and BELL parameters.
<i>NRINFO</i>	Request to send SMS message with user numbers of security system ALRNR1 – ALRNR5.
<i>PASSW:</i>	SMS password change instruction.
<i>ALRNR1:</i> <i>ALRNR2:</i> <i>ALRNR3:</i> <i>ALRNR4:</i> <i>ALRNR5:</i>	System users number programming instructions.
<i>ADDNR:</i>	Gate control mode users number programming instructions.
<i>DELNR:</i>	Gate control mode users number erasing instructions.
<i>NRLIST</i>	Request to send SMS message (messages) with all numbers stored in SIM card.
<i>SCLOCK</i>	System clock control and time setting instruction.
<i>STIMER</i>	Request to send SMS message with system timer parameters.

SMS instructions, for system programming and diagnostics

## 12. WARRANTY

MANUFACTURER AND DISTRIBUTOR is not responsible for possible theft from GsmAlarm-220 protected premises. GSM service operators are not associated to company, therefore, company takes no responsibility for GSM network services, coverage and functioning.

GsmAlarm-220 system PROVIDED with 24 month warranty. Warranty period starts with purchase date. If there are no purchasing documents, period counted starting from system manufacturing date (dated on security system identification label). Warranty is not valid if system: is reconstructed; wrongly assembled; used not on purpose; mechanical, chemical, electric damage and in other cases that are not related with GsmAlarm-220 manufacturing defects are seen.

If security system is not operating properly or breaks down, for guarantee or post-guarantee service, please contact company that performed assembling and installation of the system. Practice shows that main system operation failure reason is incorrectly performed system assembling.

Company “Elektroninēs technologijos“ declares, that product “GsmAlarm-220” satisfies all essential requirements of standard EN 60950-1:2003 following European Union directive 2006/95EC.

### 13. TECHNICAL CHARACTERISTICS

<b>GSM MODULE</b>	
Operation frequency	<b>900/1800/1900 MHz</b>
<b>MAIN POWER SUPPLY (connected to terminal “AC “)</b>	
Power supply voltage	<b>AC 16-24V</b>
Frequency AC	<b>50/60Hz</b>
Maximum current	<b>~1.2A max</b>
<b>RESERVE BATTERY (connected to terminals “BAT “ and “GND“)</b>	
Reserve battery operation voltage	<b>DC 12V</b>
Reserve battery type	<b>PB - acid</b>
Reserve battery capacity	<b>1.2 Ah max</b>
<b>OUTPUT“AUX “ (EXTERNAL DEVICES)</b>	
Output voltage	<b>DC 12V</b>
Maximum current	<b>--- 1 A max</b>
Short circuit protection triggering current	<b>--- 2 A max</b>
<b>SIREN OUTPUT “BELL” (C5)</b>	
Maximum current	<b>0.6 A max</b>
Output active (siren is on)	<b>Connected to GND</b>
Output non-active (siren is off)	<b>Open contact</b>
<b>PROGRAMMABLE OUTPUTS C1, C2, C3, C4</b>	
Maximum current	<b>150 mA max</b>
Output active	<b>Connected to GND</b>
Output non-active	<b>Open contact</b>
<b>INPUTS Z1 – Z14</b>	
Load resistance (“loaded input“ mode only)	<b>2,2 kΩ, ±10 %</b>
Temperature measurement range (temperature measurement mode only)	<b>-40°C ... +90°C, ±1°C</b>
<b>POWER CONSUMPTION (without external sensors and keypad)</b>	
Non-activated state	<b>80 mA max</b>
Call, sending SMS or speech mode	<b>350 mA max</b>
<b>OPERATING TEMPERATURE</b>	<b>-20°C...+55°C</b>
<b>DIMENSIONS</b>	<b>113 x 97 x 25 mm</b>

